

## FITTING INSTRUCTION

Clamp mark in acc. with		Cables joining
ISO	PN	
1	L	Left directional lights
2	+	Rear fog lights
3	31	Ground
4	R	Right directional lights
5	58R	Right side parking lights
6	54	Stoplights
7	58L	Left side parking lights

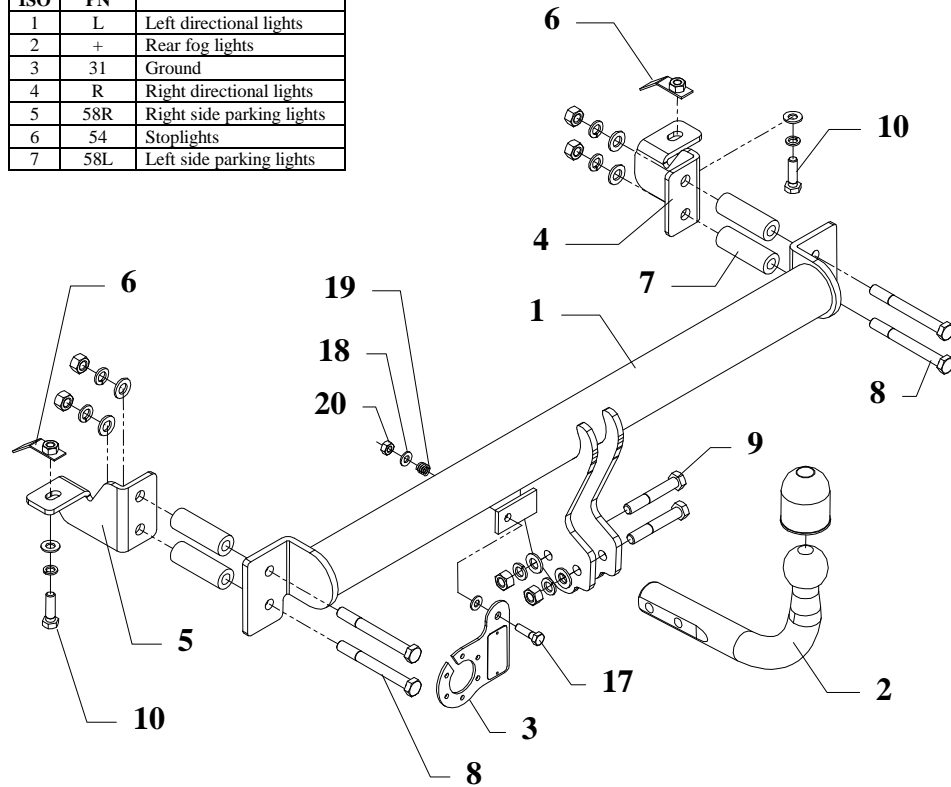

This towing hitch is designed to assembly in following cars:  
**OPEL ZAFIRA**, produced since 1998 till 2005, catalogue no. **E35** and is prepared to tow trailers max total weight **1600 kg** and max vertical load **75 kg**.

### *From manufacturer*

Thank you for buying our product. Their reliability has been confirmed in many tests. Reliability of towing hitch depends also on correct assembly and right operation. For this reasons we kindly ask to read carefully this instruction and apply to hints.

*The towing hitch should be install in points described by a car producer.*

## The instruction of the assembly

1. Disassemble the rear bumper and unscrew the metal profile.
2. Drill holes  $\varnothing 25\text{mm}$  in fabric signed points in the back panel.
3. Slide sleeves (dimension  $L=74$  – pos. 7) to drilled holes.
4. Underside the car slide special nuts (pos. 6) to chassis members, to holes fabric made, per one each side.
5. Underside the chassis member position the brackets (pos. 4 and 5) and fix it loosely with M10x35mm (pos. 10) bolts.
6. Position the main bar of the towing hitch (pos. 1) to the back panel and fix it through mounted sleeves and brackets (pos. 4 and 5) with M12x120mm – pos. 8 (M12x110) bolts.
7. Replace the metal profile and the bumper.
8. Position the ball of towing hitch (pos. 2) and fix with M12x75mm (pos. 9) screws from the towing hitch accessories.
9. Fix the socket plate (pos. 3) as shown on the drawing.
10. Fix socket plate according to drawing.
11. Tighten all nuts and bolts according to the torque shown in the table.
12. Connect the electric wires according to the instructions of the car.
13. Complete the paint cover of towing hitch (during the mounting paint cover could be destroyed).

Torque settings for nuts and bolts (8,8):	
<b>M 8</b> - 25 Nm	<b>M 10</b> - 55 Nm
<b>M 12</b> - 85 Nm	<b>M 14</b> - 135 Nm











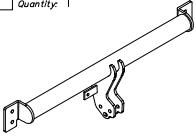





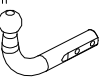

### NOTE

After install the towing hitch you should get adequate note in registration book (at authorised service station).The car should be equipped with:

- Indicators
- Tow mirrors

After 1000km check all bolts and nuts. The ball of towing hitch must be always kept clear and conserve with a grease.

## Towing hitch accessories:

Pos. 1 Name: Main bar Quantity: 1 	Pos. 5 Name: Left bracket Quantity: 1 Dim.: 111x100x85mm 	Pos. 10 Name: Bolt 8,8 B Quantity: 2 Dim.: M10x35mm 	Pos. 15 Name: Spring washer Quantity: 2 Dim.: Ø 10,2 mm 
	Pos. 6 Name: Spacial nut Quantity: 2 Dim.: 65x18mm 	Pos. 11 Name: Nut 8 B Quantity: 6 Dim.: M12 	Pos. 16 Name: Ball cover Quantity: 1 
Pos. 2 Name: Tow ball Quantity: 1 	Pos. 7 Name: Distance sleeve Quantity: 4 Dim.: Ø25xØ13; L=74mm 	Pos. 12 Name: Plain washer Quantity: 6 Dim.: Ø 13 mm 	Pos. 17 Name: Bolt 8,8 B Quantity: 1 Dim.: M8x30mm 
Pos. 3 Name: Socket plate Quantity: 1 	Pos. 8 Name: Bolt 8,8 B Quantity: 4 Dim.: M12x120mm 	Pos. 13 Name: Plain washer Quantity: 2 Dim.: Ø 10,5 mm 	Pos. 18 Name: Plain washer Quantity: 2 Dim.: Ø 8,5 mm 
Pos. 4 Name: Right bracket Quantity: 1 Dim.: 111x100x85mm 	Pos. 9 Name: Bolt 8,8 B Quantity: 2 Dim.: M12x75mm 	Pos. 14 Name: Spring washer Quantity: 6 Dim.: Ø 12,2 mm 	Pos. 19 Name: Spring Quantity: 1 
			Pos. 20 Name: Nut 8 B Quantity: 1 Dim.: M8 



**PPUH AUTO-HAK S.J.**

Produkcja Haków Holowniczych  
Henryk & Zbigniew Nejman  
76-200 SŁUPSK ul. Słoneczna 16K  
tel/fax (059) 8-414-414; 8-414-413  
e-mail: [office@autohak.com.pl](mailto:office@autohak.com.pl)  
[www.autohak.com.pl](http://www.autohak.com.pl)

## Towing hitch (without electrical set)

Class: **A50-X** Cat. no. **E35**  
Designed for:  
Manufacturer: **OPEL**  
Model: **ZAFIRA**  
produced since 1998 till 2005

Technical data:  
**D-value: 8,9 kN**  
maximum trailer weight: **1600 kg**  
maximum vertical cup load: **75 kg**

**Approval number acc. to regulations EKG/ONZ 55.01: E20-55R-01 0807**

## Foreword

This towing hitch is designed according to rules of safety traffic regulations. The towing hitch is a safety component and can be install only by qualified personnel. Any alteration or conversion of the towing hitch is prohibited and would lead to cancellation of design certification. Remove insulating compound and underseal from vehicle (if present) in the area of the matting surfaces of the towing hitch. The vehicle manufacturer's specifications regarding trailer load and max. vertical cup load are decisive for driving, and values for the towing hitch cannot be exceeded.

*D-value formula:*

$$\frac{\text{Max trailer weight [kg]} \times \text{Max vehicle weight [kg]}}{\text{Max trailer weight [kg]} + \text{Max vehicle weight [kg]}} \times \frac{9,81}{1000} = D \text{ [kN]}$$